

# FENIX

— NEO —



## USER MANUAL

### Thank you for purchasing the FENIX NEO vaporizer!

In order to ensure safe use, please read all instructions and safety warnings before operating. Failure to follow instructions may result in injury and may void your warranty.

#### Warnings and precautions:

This device is designed and intended for use with legal dry herbs for aromatherapy purposes only. Use with tobacco, nicotine-containing or illegal substances is prohibited. Keep out of the reach of children. Do not use this device if you are pregnant or nursing.

The manufacturer/importer will not take responsibility for damages caused by inappropriate, wrong or unreasonable use. Never use electronic devices near water. Never block or cover ventilation openings. Only use original accessories recommended by FENIX. Maintenance and repair should only be carried out by qualified personnel. To avoid electric shock, do not open the device by yourself. For safety reason, it is only allowed to have the device opened by qualified personnel. As long as the device is operation, do not leave it unattended.

1

Please seek medical support immediately, if negative side effects occur during or after use.

**CAUTION!** Some parts - especially the Filling chamber - can get very hot. Do not touch or clean these parts until they have completely cooled down.

#### Disposal:

As for environmental protection, at the end of device's useful life, owner should recycle separately from the unsorted municipal waste. Waste electronic equipment must not be disposed as unsorted municipal waste and in particular does not belong in the household waste. Disposal can be made through available local return and collection systems.

#### Warranty:

This device is covered by a 2 years warranty from the date of purchase. Proof of the purchase date is the invoice issued by the retailer, which must state the name of the appliance, the name of purchaser and the date of purchase.

2

### FENIX NEO Vaporizer Overview

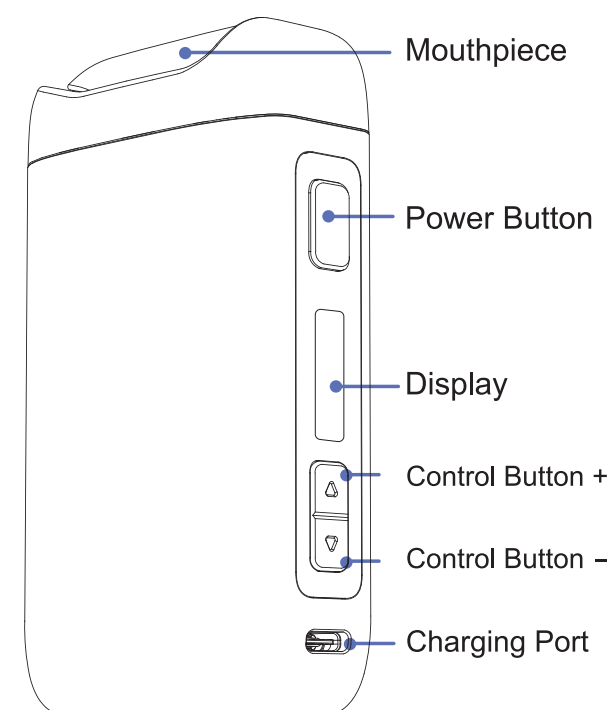

3

### Includes

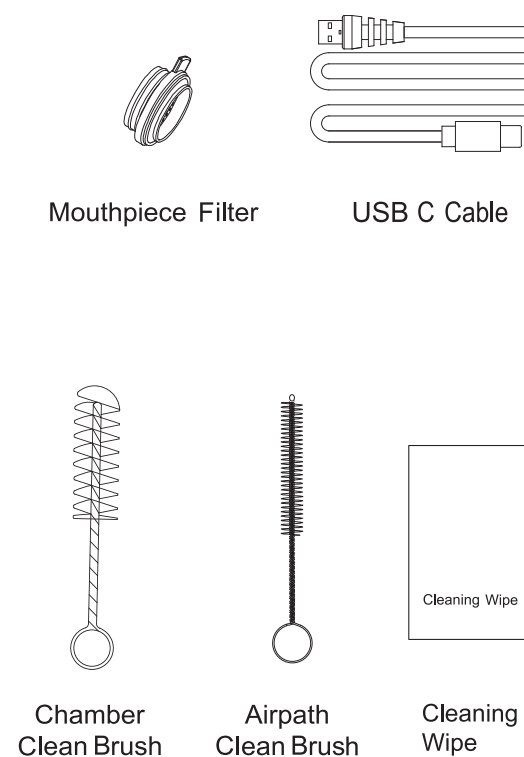

4

### Important Usage Tips

- Rapidly press power button **5 times** On/Off with Vibration feedback.
- Press and hold power button and “-” button simultaneously within **2 seconds** to change from Fahrenheit to Celsius degrees or from Celsius to Fahrenheit.
- Working time setting, hold power button in **2 seconds** until cursor position under SET of timer, press control button +/- to adjust working time from 180 to 420 seconds.
- **248-430 °F / 120-221°C** Temperature reached with Vibration Feedback.
- Display indicates temperature information, battery status, duration timer.
- Quick battery check : one hit on power button when device is off , the icon on screen will show remaining battery level.

5

### Display Indication



#### Fahrenheit Display

The default display is Fahrenheit. Mark SET (page 4) to select the temperature.

#### Celsius Display

Mark SET (page 4) to select the temperature.

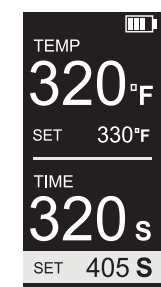
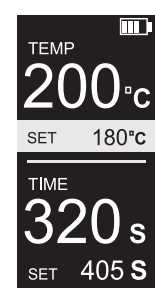

#### Timer Display

Mark SET (page 4) to select the operating time.

6

### How To Load Dry Herb

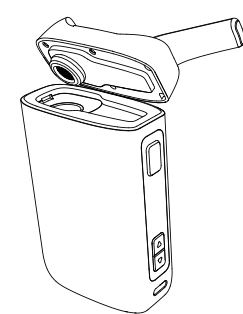

- 1 Remove mouthpiece from the device.

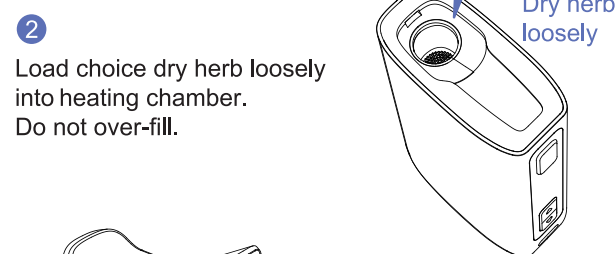

- 2 Load choice dry herb loosely into heating chamber. Do not over-fill.

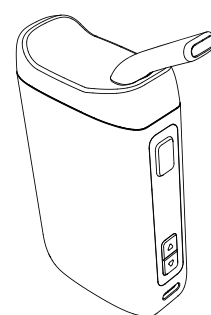

- 3 Attach the mouthpiece back to device.

7

### How To Clean Heating Chamber

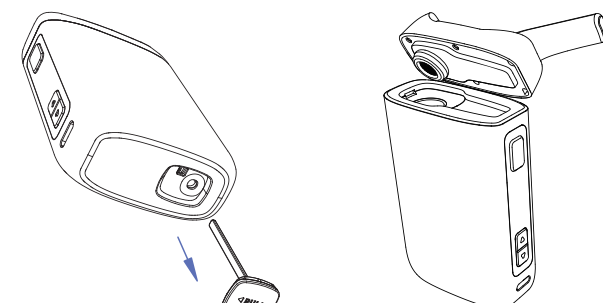

- 1 Pull out the magnetic tool.
- 2 Remove mouthpiece from the device.

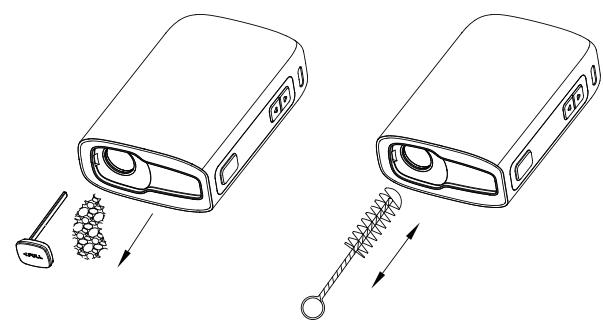

- 3 Remove material from chamber.
- 4 Use the cleaning brush to remove the remaining residue from chamber.

8

### Load/Remove The Mouthpiece Components

- When load or remove mouthpiece components, please open the mouthpiece firstly .

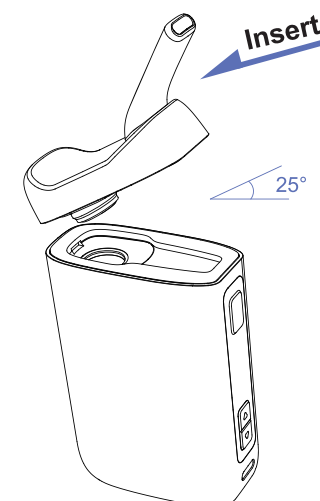
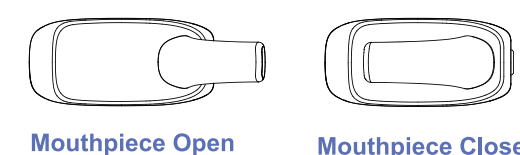

- Place mouthpiece components and device at 25° angle, it will be magnetically attached to the device.

- When remove follow above steps in reverse.

9

### How To Maintain The Zirconia Vapor Path

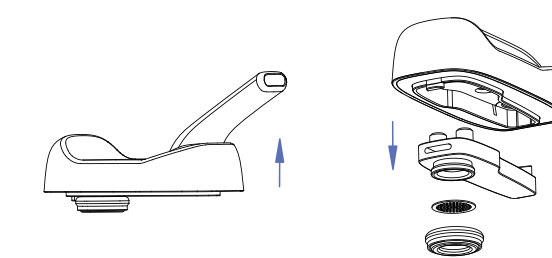

- 1 The zirconia mouthpiece stem can be removed for cleaning or replacing.
- 2 FENIX NEO's zirconia vapor path can be pulled out for cleaning or replacing.

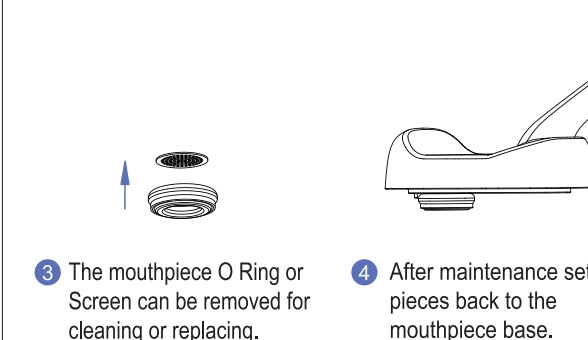

- 3 The mouthpiece O Ring or Screen can be removed for cleaning or replacing.
- 4 After maintenance set all pieces back to the mouthpiece base.

10

### Charging Instructions

- Battery capacity **3000 mAh**, USB C charging, **5V/2A** suggested.
- Initially charge the FENIX NEO for **2 hours**.The battery will stop charging when the icon is full.
- When battery level is low, charge battery with included USB C cable to compatible wall charger. Low battery level will be indicated with icon .
- Do not use FENIX NEO while charging.

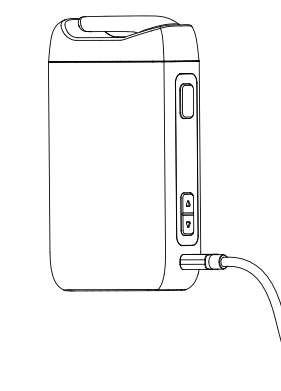

11